



**POWER INVERTER**  
**PURE SINEWAVE**

## **MEXTS / MEXTC SERIES**

---

Installation and  
Operating Instructions

**KULLANIM KILAVUZU**

**mexx** **SUN**<sup>®</sup>

**YENİLENEBİLİR ENERJİ LTD ŞTİ.**

# English version

---

## Index

Introduction	2
What is an inverter?	2
Explanation of the symbols	2
General safety instructions for installation	3
Scope of delivery	7
Accessories (available separately)	7
Recommend battery cables and batling capacity	7
Key technical data	9
Overview of the controls	10
Operating conditions	13
<b>MEXXSUN MEXTC 3-Stage IUoU-Charger</b>	16
Installation	17
<b>MEXXSUN MEXTC Mains Priority Circuit (MPC)</b>	
Uninterruptible Power Supply (UPS)	18
Recommended battery capacity	19
Safety functions	20
Troubleshooting – Error codes	21
Possible configurations of batteries	24
Overwintering / Prolonged non-use	25
Warranty	25
Disposal	26

## Introduction

---

Thank you for choosing our **MEXXSUN** sine wave inverter.

Our inverters are compact and highly efficient inverters and are leading the way in the field of high-frequency inverters.

This user manual contains important information about installing and using the **MEXXSUN** sinus inverters.

We therefore ask you to read this manual carefully and attentively before using the product.

The user manual is intended for the installer and end user of the **MEXXSUN** inverter.

The inverter must only be installed and serviced by qualified personnel.

This is the original manual, keep it in a safe place!

## What is an inverter?

---

An inverter is a device that converts direct voltage into sinusoidal alternating voltage.

In the case of the **MEXXSUN** inverter, the direct current (DC) is usually provided by a battery. The inverter converts direct current (DC) into alternating current (AC).

With this **MEXXSUN** inverter, you can operate devices that would require a 220V household mains connection independently and autonomously thanks to the 220V socket output.

## Explanation of the symbols

---

This operating manual contains important safety and installation instructions that are required for proper and safe operation.

The following icons are in the guide to highlight dangerous and important situations.

Please note these symbols in the appropriate place and exercise caution.

### **Warning!**

Failure to observe this notice may result in serious injury or death.

### **Attention!**

Failure to observe this notice may interfere with the function of the device or cause damage to the device.

### **Note!**

Additional information on how to operate the device.

## General safety instructions for installation

---

Before installing, read the User's Guide carefully. It is designed to make it easier for you to operate and install safely the MEXXSUN inverters. It is essential that any person working on or with the inverter knows the contents of this User's Guide and follows the instructions and safety instructions contained therein.

### **Warning!**

#### *Restricted user base*

The following persons should use this product only under the supervision of another responsible person:

- Persons with limited physical abilities.
- Persons with limited mental abilities.
- Persons with limited sensory abilities.
- Children under 12 years of age.
- Use the device only for proper use.
- Keep the device out of reach of children.
- Maintenance and repair may only be carried out by a specialist who is familiar with all current guidelines.

### **Warning!**

#### *Notes on installation*

- The installation of the device may only be carried out by appropriately trained personnel and only in compliance with all applicable safety regulations and guidelines.
- Especially when using the device on boats, corrosion damage can occur due to faulty installations. The installation should therefore be carried out by trained boat electricians.



## **Warning!**

### *Important installation instructions!*

In order to avoid danger, in particular due to fire hazard, injury and electric shock, the following instructions must be observed:

- The device can be installed both horizontally and vertically.
- Never cover the ventilation inputs or outputs and ensure generally good ventilation. The installation location of the inverter must always be generously ventilated: Make sure that the distances between ventilation and outputs and the nearest surface are at least 25 cm.
- Install or screw the inverter only on fixed mounting surfaces.
- Avoid pulling cables.
- Hold all cables well during assembly and disassembly.
- Always connect the input voltage first and then switch on the inverter.
- Avoid direct long sunlight and installation near heat sources.
- Avoid dust, moisture and corrosive or combustible substances near the inverter.
- The inverter becomes warm during operation. Avoid being close to temperature-sensitive items.
- Do not drop the inverter and avoid impacts.
- Do not place any objects on the inverter.
- Do not open the device.
- Use only dry cloths for care. Turn off the inverter beforehand.
- Turn off the inverter beforehand during all work.
- Always use empty tubes or cable bushings for sharp-edged penetrations.
- Never install the 220V output line and DC power lines together in the same line channel.
- The device is to be operated only to the exclusion of any damage.
- The inputs and outputs of the ventilation must always be kept free.
- When working on the device, the power supply must be interrupted.
- Use commercially available accumulators of the specified rated voltage. Installation only in permanently installed systems.
- The specified minimum battery capacity must be adhered to.
- Use the supplied battery cable.
- If you need a longer battery supply line, follow the minimum cross-sections and maximum lengths specified by us.
- Use the MEXXSUN inverters only in technically perfect condition.

- The devices may only be installed in dry and dust-free rooms. The MEXXSUN inverters must be kept away from aggressive battery gases.
- There are no parts of the inverter that need to be serviced or repaired by the user. Never open the MEXXSUN inverter or carry out appropriate repairs.
- Disconnect the connection (DC) to the battery before installing or dismantling the MEXXSUN inverter.
- Install the line fuses as required by the user manual.
- Make sure that the line connections have appropriately fixed seat to avoid heating by local connections.
- The device must never be installed in places where there is a risk of gas or dust explosion!
- Never operate the device outdoors.
- Never connect external voltage (mains voltage) or a generator or other inverter to the sockets of the MEXXSUN inverter, as this will destroy the unit.
- Never install 12V cables and 220V lines in a common conduit or cable duct.
- All voltage-carrying cables must be regularly checked for insulation faults, breakpoints, as well as for loose connections.  
Defects found must be rectified immediately.
- When working on the electrical system and during welding work, the device must be disconnected from all connections.
- Compliance with the building and safety regulations of any kind is subject to the user or buyer.
- Follow the recommendations and safety regulations of the battery manufacturer.
- The device must not be opened under any circumstances. It does not contain any parts that need to be replaced by the user. Please note that dangerous voltages are present after disconnecting the device from the battery for a long time.
- Keep children away from batteries and inverters.
- In the event of improper use of the device, when operating outside the technical specification, as well as in case of improper operation or third-party intervention, the warranty expires. No liability is assumed by the manufacturer for the resulting damages.

## **Attention!**

*Pay attention to adequate ventilation!*

The inverter produces loss heat. The device is equipped with thermal overload protection. In case of insufficient ventilation, the function of the inverter may be impaired, as the inverter can be switched off for safety reasons.

## **Attention!**

*Risk of electric shock!*

- Do not expose the inverter to rain, snow, spray water or water. This inverter is designed for indoor use only.
- Do not operate the inverter if it has received a hard blow, has been dropped or has cracks.
- Disconnect both AC and DC current from the inverter before attempting to perform maintenance or cleaning work connected to the inverter.
- Make sure that all cabling is in good condition and is not undersized.
- Do not operate the inverter with damaged or inferior wiring.
- Do not open the inverter!  
Internal capacitors remain charged after the power supply is disconnected.

## **Warning!**

***Failure to follow these instructions may result in death or serious injury!***

## Scope of delivery

- 1 x MEXXSUN inverter
- 1 x Connection cable (80cm)
- 1 x User Manual
- 1 x 220V Cold device plug (100cm - MEXTC series only)  
MEX3000TC do not match this plug

## Accessories ( MEXTC Series Only )

- 1 x Remote control
- 1 x 5 m extension cable for remote control

## Recommended battery cables and battery capacity

(Batteries not included)

Models	Input voltage	Recommended cross-section from 80cm	Recommended cross-section from 150cm	Recommended cross-section from 200 cm	Recommended cross-section from 300 cm	Battery capacity
MEX300TS MEX300TC	12V	4 mm <sup>2</sup>	10 mm <sup>2</sup>	16 mm <sup>2</sup>	25 mm <sup>2</sup>	>= 100 Ah
	24V	2,5 mm <sup>2</sup>	6 mm <sup>2</sup>	10 mm <sup>2</sup>	16 mm <sup>2</sup>	>= 50 Ah
MEX600TS MEX600TC	12V	6 mm <sup>2</sup>	16 mm <sup>2</sup>	25 mm <sup>2</sup>	35 mm <sup>2</sup>	>= 100 Ah
	24V	2,5 mm <sup>2</sup>	10 mm <sup>2</sup>	16 mm <sup>2</sup>	25 mm <sup>2</sup>	>= 50 Ah
MEX1000TS MEX1000TC	12V	10 mm <sup>2</sup>	25 mm <sup>2</sup>	35 mm <sup>2</sup>	50 mm <sup>2</sup>	>= 160 Ah
	24V	6 mm <sup>2</sup>	16 mm <sup>2</sup>	25 mm <sup>2</sup>	35 mm <sup>2</sup>	>= 80 Ah
MEX1500TS MEX1500TC	12V	16 mm <sup>2</sup>	35 mm <sup>2</sup>	50 mm <sup>2</sup>	70 mm <sup>2</sup>	>= 250 Ah
	24V	10 mm <sup>2</sup>	25 mm <sup>2</sup>	35 mm <sup>2</sup>	50 mm <sup>2</sup>	>= 120 Ah
MEX2000TS MEX2000TC	12V	25 mm <sup>2</sup>	50 mm <sup>2</sup>	70 mm <sup>2</sup>	100 mm <sup>2</sup>	>= 320 Ah
	24V	10 mm <sup>2</sup>	35 mm <sup>2</sup>	50 mm <sup>2</sup>	70 mm <sup>2</sup>	>= 160 Ah
MEX3000TS MEX3000TC	12V	35 mm <sup>2</sup>	100 mm <sup>2</sup>	120 mm <sup>2</sup>	140 mm <sup>2</sup>	>= 480 Ah
	24V	16 mm <sup>2</sup>	50 mm <sup>2</sup>	70 mm <sup>2</sup>	100 mm <sup>2</sup>	>= 240 Ah

\* The given values are indicative values.

## Attention!

*Observe capacity!*

If the recommended total capacity of the batteries is exceeded, performance or severe usage limitations may occur due to voltage drops.

## Warning!

*Fire!*

The cable cross-section of the battery cables may also be larger than recommended in order to further limit the loss of power. Failure to do so can easily overheat the overloaded cables and junctions and cause a dangerous cable fire.

Connect inverter and battery with a set of cables

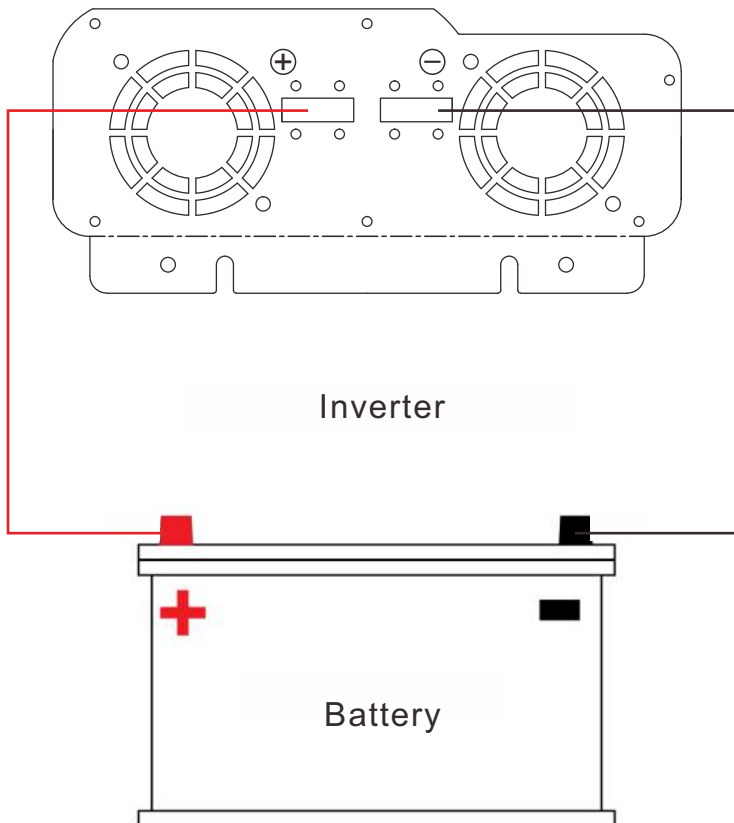

## Key technical data

### MEXXSUN MEXTS Series

Model	Performance	Dimensions (L x W x H)	Weight
MEX300TS	300W	130 x 150 x 55 mm	1.3KG
MEX600TS	600W	210 x 150 x 70 mm	2.0KG
MEX1000TS	1000W	280 x 220 x 75mm	3,0 kg
MEX1500TS	1500W	250 x 220 x 85 mm	3.9KG
MEX2000TS	2000W	320x 220 x 85 mm	4.7KG
MEX3000TS	3000W	380 x 220 x 85 mm	7.5KG

### MEXXSUN MEXTC Series

Model	Performance	Dimensions (L x W x H)	Weight
MEX600TC	600W	310 x 150 x 70 mm	2.9KG
MEX1000TC	1000W	350 x 150 x 70 mm	3.4KG
MEX1500TC	1500W	340 x 220 x 85 mm	5.1KG
MEX2000TC	2000W	410x 220 x 85 mm	6.0KG
MEX3000TC	3000W	460 x 220 x 113 mm	7.9KG

### Power AC charger MEXTC series

Model	Charging current
<b>24V Models:</b> MEX300TC, MEX600TC, MEX1000TC	5 A
<b>24V Models:</b> MEX1500TC, MEX2000TC, MEX3000TC	10 A
<b>12V Models:</b> MEX300TC, MEX600TC, MEX1000TC	
<b>12V Models:</b> MEX1500TC, MEX2000TC, MEX3000TC	20 A

# MEXTS Series

## Overview of the controls

Illustrations show the most important external components and connections.

Front view:

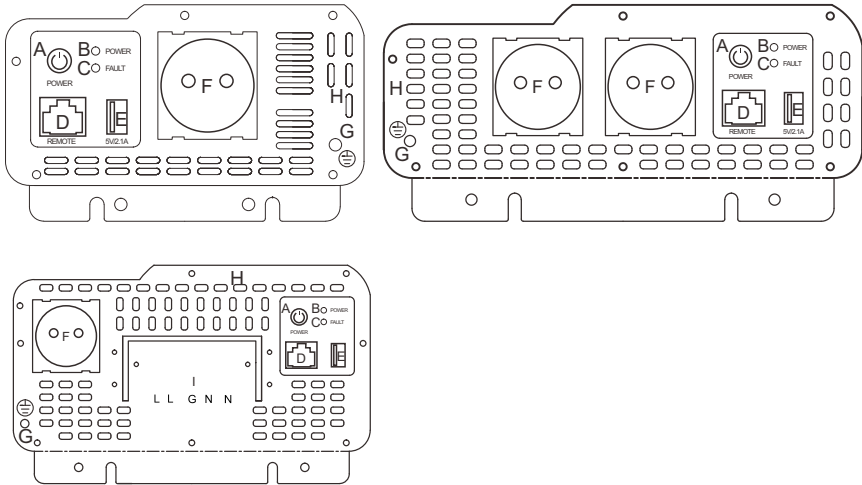

- |                 |                      |                           |
|-----------------|----------------------|---------------------------|
| A. Power ON/OFF | D. Remote control    | G. Earth leakage          |
| B. LED "POWER"  | E. USB Port 5V 2.1A  | H. Vent outlet            |
| C. LED "FAULT"  | F. 220V power socket | I. Shore power connection |

### Terminal for direct connection ( MEX3000TS)

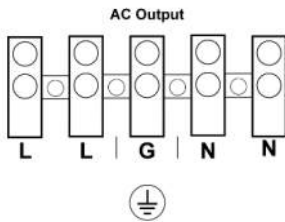

### **⚠ Attention!**

*Observe the maximum power of the consumers!*

For currents >15A, consumers must be connected directly to the terminal for direct connections.

# MEXTC Series

## Overview of the controls

Illustrations show the most important external components and connections.

### Front view:

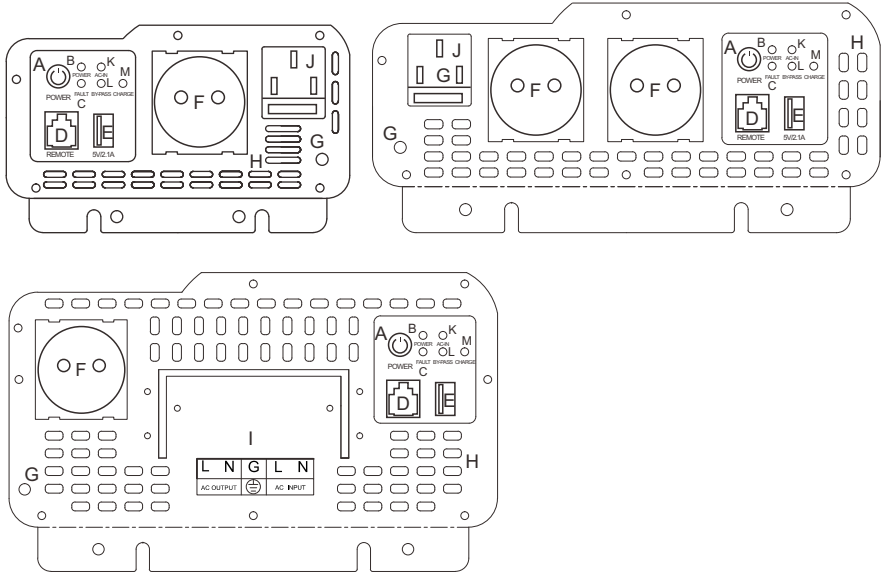

- A. Power ON/OFF
- B. LED "POWER"
- C. LED "FAULT"
- D. Remote control
- M. LED "CHARGER"
- E. USB Port 5V 2.1A
- F. 220V power socket
- G. Earth leakage
- H. Vent outlet
- I. Shore power connection
- J. AC Input Plug
- K. LED "AC-IN"
- L. LED "BY-PASS"

### Terminal for direct connection ( MEX3000TC)

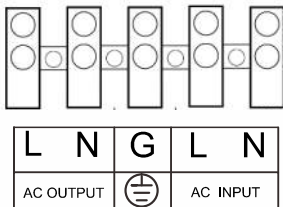

### Attention!

Observe the maximum power of the consumers!

For currents >15A, consumers must be connected directly to the terminal for direct connections.



# MEXTC Series only

## Overview of the Remote control display



- A) Battery Indication
- B) Battery voltage
- C) AC output running
- D) Power consumption
- E) AC output voltage
- F) Inverter operating



- A) Battery Indication
- B) Battery voltage
- C) AC output running
- D) Power consumption
- E) AC output voltage
- F) Mains connected (transferswitch/By-pass and charging)

## **Warning!**

### *Fire!*

The **MEXXSUN** inverters of the **MEXTS/MEXTC** series are intended exclusively for use in self-sufficient, so-called "off-grid" areas. Do not connect the inverter output (socket) to another AC voltage source. For all models, only the specially designed AC input may be connected to a power grid. In case of disregard, there is danger of life and immediate destruction of the inverter.

## **Attention!**

The inverter must not be used in vehicles in which the plus pole is connected to the body!

## **Attention!**

### *Observe the input voltage!*

The inverter may only be connected to voltage sources which are released according to its destination.

**12V = 12V    24V = 24V**

Connecting to higher voltages than the intended voltage, leads to immediate burning of the fuse and can lead to the destruction of the inverter.

## Operating conditions

---

### Everything at a glance

Power output as % of continuous output	120% - 150% for up to 10 seconds 150% - 200% for up to 2 seconds
MEXTS/MEXTC SERIES	220V
	AC voltage fluctuations: max. 10%
	Frequency: 50Hz $\pm$ 1Hz
Waveform	Pure sine wave (THD < 4%) at rated input voltage
Types of batteries	Wet, AGM, GEL, Li-Ion (only with BMS)
Switchover time UPS (MEXTC series)	< 16 ms
Noise at full load	Approximately 60-70 decibels (dB)

** Attention!***Current consumption idle!*

When not in use, switch off the inverter with the main switch, otherwise the current will be absorbed in idle mode according to this table. This protects your battery from damage caused by deep discharge.

**Idle current consumption/ Power consumption – MEXTS/MEXTC series**

Model	12V	24V
MEX300TS/MEX300TC	ca. 0,55 A	ca. 0,35 A
MEX600TS/MEX600TC	ca. 0,65 A	ca. 0,35 A
MEX1000TS/MEX1000TC	ca. 0,70 A	ca. 0,35 A
MEX1500TS/MEX1500TC	ca. 0,90 A	ca. 0,45 A
MEX2000TS/MEX2000TC	ca. 1,00 A	ca. 0,50 A
MEX3000TS/MEX3000TC	ca. 1,20 A	ca. 0,60 A

** Note!***Note the starting currents!*

When connecting inductive devices (electrical operation e.g. drill, refrigerator, etc.), note that they often require a 3-10 times higher surge power at short notice to start up than indicated on the type plate. The maximum short-term power query must not exceed the maximum power of the inverter.

** Note!***Observe acoustic signals!*

In the event of an overload, an acoustic signal will sound. If the required power is not reduced to the maximum continuous power within the specified time, the inverter switches off automatically.

** Note!***Loss of performance due to heat!*

At ambient temperatures above 40°C (e.g. due to hot installation locations or direct sunlight) the predetermined performances and efficiency levels are reduced.

## Recommended environmental conditions:

Max. Working temperature	-15°C to +40°C
Max. Storage temperature	-40°C to +85°C
Max. Relative humidity	20% to +90%

## Efficiency range\*:

System voltage	MEXXSUN MEXTS/MEXTC Series
12V	86% - 93%
24V	87% - 94%

\*Actual efficiencies depend on the type of consumer and utilization. For example, the inverter typically has the highest efficiencies at a load of approx. 70%.

## MEXTC 3-Stage IUoU-Charger

### Explanation of the loading phases MEXTC series

The integrated charger of the MEXTC series charges with a fully automatic 3 step IUoU charging characteristic described in the following points.

#### Main charge (Bulk):

The battery is charged at a steady current and carefully increasing voltage up to a predefined maximum voltage value until 80% of the total charge has been reached.

#### Residual charge (Absorption):

The battery is fully charged from 80% to 14.4V\* to 100% capacity by constant voltage and gradually decreasing currents. The gradually decreasing current ensures that the terminal voltage does not become too high during the full charge.

#### Charge conservation (float):

The battery is kept evenly at 13.8V\* "float voltage" without overcharging or damaging the battery. The voltage in this mode is permanently controlled. As soon as the voltage of the battery drops to a predefined level, the battery is charged again to 100% by a pulse charge and thus constantly kept between 95% and 100% state of charge. This cycle repeats itself as needed and thus has a positive effect on the battery's service life.

Level	Strom	Spannung	Kapazität
Main load (Bulk)	100%	increasing to approx. 14,4V*	to 80%
Residual charge (Absorption)	falling	increasing from 14,4V*	from 80% to 100%
Charge Conservation (Float)	under 20%	13,6V*	95% to 100%

\* All voltage values refer to 12V. For 24V: double value. The voltage tolerance is  $\pm 0.2V$ .

## Attention!

Make sure the inverter is turned OFF before connecting to the battery.

## Attention!

- Reverse polarity will blow the fuse or damage the inverter. Damage caused by incorrect connection is not covered by the warranty.
- The inverter may only be connected to batteries with a normal output voltage of 12V or 24V.
- Provide adequate ventilation when using batteries.  
Batteries can produce flammable gases during charging or discharging.
- Sparks may be generated when the inverter is connected to the battery, so make sure there are no flammable vapours before making the connections.

## Attention!

We recommend not to use consumers whose power is more than 90% of the rated power of the inverter.

## Installation

The MEXXSUN inverter is supplied at the factory with a 80cm long battery cable.

1. Make sure that the ON/OFF POWER of the device is set to **"OFF"**.
2. The **red cable (+)** is connected to the **plus pole** (red marking) of the inverter.
3. The other free end is then connected to the battery (plus pole) via a fuse.
4. The fuse should be placed as close as possible to the battery side.
5. The **black cable (-)** is connected to the **negative pole** (black marking) of the inverter.  
The other free end is connected to the battery (minus pole).
6. After connecting the two battery cables to the DC connectors of the inverter, the two covers (red & black) must be attached.
7. Insert the red cover over the open red cable end and fasten it to the unit with the enclosed screws. Also insert the black cover over the black negative cable and fasten it to the unit with the enclosed screws.



## Attention!

In order to protect against cable fires, it is mandatory and the battey in the PLUS line!

to install a fuse between the inverter

Install the fuse as close to the battery side as possible.

## **Note!**

### *Sparking!*

When connecting the input DC voltage source, sparking occurs due to the charging of the internal capacitors.

## **Grounding**

The MEXXSUN inverter has an M5 earth bolt. This is used to connect the inverter to the vehicle ground.

The grounding of the two output sockets (220V) are already internally connected to the M5 grounding bolt.

## **Warning!**

### *Danger of electric shock!*

The device is basically equipped with safety features that can prevent dangerous electric shocks.

However, in order to ensure the highest possible safety in operation, it is imperative that the grounding connection of the inverter is connected to a protective earthing system (usually green-yellow cable) in each case.

## **Mains Priority Circuit (MPC) - Uninterruptible Power Supply (UPS)**

---

**The switching time is less than <16 milliseconds, thus guaranteeing an uninterruptible power supply (UPS).**

The **MEXXSUN** inverters are suitable for additional operation with an external mains (shore power).

The sockets on the unit serve both as a 220V output in the case of a mains feed-in and as a 220V mains power supply in the case of pure inverter operation (no shore power connected).

The unit is connected to a 220V socket via the enclosed mains connection cable (100 cm) with IEC plug, which is supplied with shore power via the mains. The supply cable to the unit should be fitted with a strain relief!

Switching between mains and inverter operation is fully automatic.

If no shore power is fed in, the unit operates purely as an inverter. The unit's internal safety relay ensures that the unit automatically switches back to inverter mode immediately after the shore power supply line is removed.

### **UPS-Mode (Uninterruptible power supply):**

In UPS mode, also called mains priority (MPC), the current discharge from the battery is stopped.

The unit is designed to automatically switch to mains operation when connected to the mains (shore power).

## **Note!**

The unit can be easily switched on and off via the remote control.

**Connection diagram:**

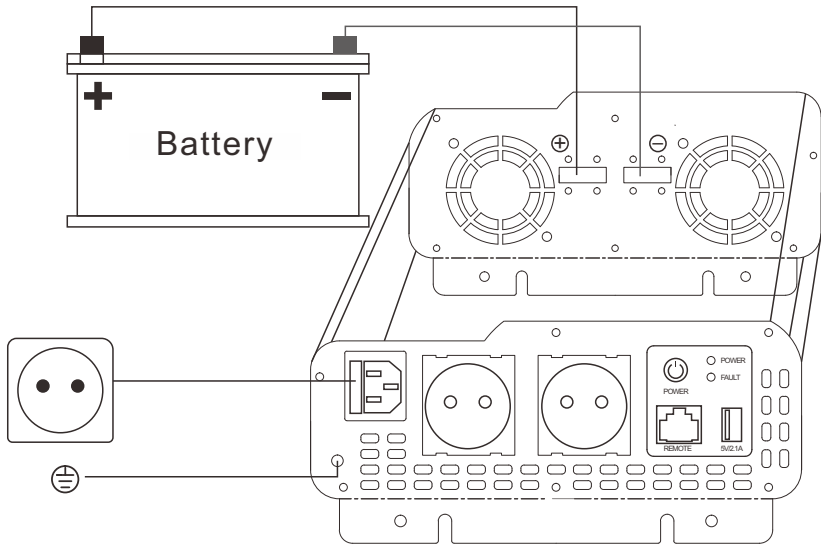

**⚠ Attention!**

In mains priority operation, the 220V consumers may be supplied up to the load limit of the inverter and under no circumstances exceed the power of the inverter!

The maximum load capacity of the AC input is 16A for IEC plugs. Higher powers will cause the internal safety relay to malfunction.

The respective national installation and safety regulations for protection against electric shock must be observed.

**⚠ Attention!**

Battery chargers must never be operated via the mains priority circuit and thus not by the inverter.

## Recommended battery capacity

In order for the MEXXSUN inverter to be operated without any problems and without interference, sufficient battery capacity should be available.

While small consumers charge only a little to the battery, larger consumers such as hair dryer (1000W - 1200W) flows a very high current (up to 100A).

When using a 12V battery with 100Ah, a maximum of 50% of the capacity can be used, which corresponds to about 50Ah.

Thus, with a sampling current of 100A, the battery is discharged in about 30 minutes.

In comparison, lithium batteries can take the complete 100Ah (useful capacity).

### Note!

The battery should have a minimum capacity of 90Ah.

This is the minimum requirements for optimal operation. This information refers to lead accumulators.

## Maximum connection power

In order to ensure safe and trouble-free operation of the device, the sum of the connection power of the connected devices (power indication in VA or W) must not exceed the rated power of the MEXXSUN inverter.

The rated power of inverters is given as follows:

- Maximum AC continuous power.
- Surge power for a high, short-term increase in performance when certain AC devices are switched on.

Type of consumer	Multiplier
Air conditioning, Refrigerator, Freezer (compressor based)	5
Pond pump, Submersible pump	4
Glow, Halogen or Quartz lamps	3
Switching power supplies (SMPS): without power factor correction	2
Dishwasher, Washing machine	3
Air compressor	4

Multiply the maximum continuous power (in watts) of the consumer by the recommended multiplier to achieve the maximum continuous power of the inverter.



## Operating time

The batteries must supply between 10.5V and 15.5V DC (for 12V inverters) and be capable of supplying the current required to operate the load.

The current source should be a well-conditioned battery.

To get a rough estimate of the current (in amps) that the power source must supply, simply divide the current consumption of the load (in watts AC) by 10.

### Example:

If the load is rated for 100 watts AC, the power source/battery must be able to deliver:  $100/10 = 10A$ .

For larger applications, the power source may consist of several batteries connected in parallel.

It is important that the cables are sufficiently thick to limit power loss.

This manual does not describe all possible types of battery configurations, battery charging configurations and battery isolation configurations.

We recommend the use of deep cycle or LiFePO4 batteries. If you see a low voltage alarm, recharge the battery immediately. When the battery is fully charged, you can reuse the inverter.

*The battery operating time depends on battery capacity (Ah) and consumption (Watts).*

*The method for calculating operating time is:*

**Battery capacity (Ah) x Input voltage (V) / Consumption (W) = time (in hours h)**

<b>Example:</b> Battery capacity	= 100Ah	
Input voltage	= 12V	
Consumption	= 180W	<b><u><math>(100Ah \times 12V) / 180W \approx 7h</math> (hours)</u></b>

## Safety functions

---

### Note!

*Switching on again is necessary!*

The inverter is equipped with a variety of safety functions to protect the inverter, as well as all connected components, such as the battery.

The inverter is equipped, among other things, with thermal and electrical under or over voltage protection. In case of under- or over-voltage, the device disconnects the AC-output and must be switched off and Powered on again via the ON/OFF switch before recommissioning.

### Attention!

The unit still remains switched on when the AC output is disconnected. Due to the power consumption of this standby mode, there is a risk of deep discharge of connected batteries.

In the following cases, the inverter separates the AC-output:

- Internal temperature too high.
- Required performance too high.
- Input voltage is either too high or too low.



Reason	12V	24V	Action
Impending Undervoltage	10,8V ± 0,2V	21,6V ± 0,4V	2x signal tone + red LED flashes; Inverter continues to operate
Absolute Undervoltage	10,2V ± 0,2V	20,4V ± 0,4V	3x signal tone + red LED flashes; Automatic switch-off
Overvoltage	15,5V ± 0,2V	31,0V ± 0,4V	4x signal tone + red LED flashes; Automatic switch-off
Overheating	Internal temperature > 75°C		5x signal tone + red LED flashes; Automatic switch-off
Overload through Consumers	Regardless of the model		11 x signal tone + red LED flashes; Automatic switch-off Automatic switch-off
Short circuit Consumers	Regardless of the model		6x signal tone + red LED lights up; Automatic switch-off

## Note!

*Disclaimer*

Damages caused by reverse polarity and short circuits are excluded from liability.

## Troubleshooting – Error codes

Symbols	Explanation
	<b>LED lights up green</b> to indicate that the unit is ready for operation and that AC voltage is present at the two output sockets.
	<b>LED lights up red</b> if connected devices load the inverter due to excessive current values or in the event of a short circuit.
	<b>Alarm Tone sounds</b> when the unit has switched off due to a malfunction.

## Attention!

*Eliminate sources of error immediately!*

Make sure that the source of the error has been fixed. Turning on several times in case of any problems, can destroy the device.

In particular, short-circuits and revers polarity must be avoided in any case, as these can destroy the device despite the protection.

Symptom	Possible cause	Solution
<ul style="list-style-type: none"> <li>• Inverter switched on</li> <li>• Status LED does not light up</li> <li>• No acoustic signal</li> <li>• No output voltage</li> </ul>	There is no voltage at the input	<ol style="list-style-type: none"> <li>1. Check battery voltage</li> <li>2. Check input fuses</li> <li>3. Check all connections to the battery</li> </ol>
	<p>Blown fuses due to polarity reversal.</p> <p>Attention: Reverse polarity can damage the inverter despite the fuse.</p>	<ol style="list-style-type: none"> <li>1. Replace the blown fuses and connect the cables correctly.</li> <li>2. If the inverter does not work after replacement, it has probably been damaged.</li> <li>3. Call the support!</li> </ol>
Acoustic signal sounds once	<ol style="list-style-type: none"> <li>1. Connection to consumers torn off</li> <li>2. Short circuit on consumers</li> </ol>	<ol style="list-style-type: none"> <li>1. Check connection</li> <li>2. Check for short circuit</li> </ol>
Acoustic signal sounds 2x and red LED flashes 2x every 8 seconds	Impending undervoltage reached (see table)	<ol style="list-style-type: none"> <li>1. Check battery charge level, recharge if necessary</li> <li>2. Check battery cable for compatibility, use higher cross-section if necessary</li> <li>3. Check conductive parts (e.g. cables, terminals, cable lugs) for damage</li> </ol>
Acoustic signal sounds 3x times and red LED flashes	Absolute undervoltage reached (see table)	<ol style="list-style-type: none"> <li>1. Check battery charge level, recharge if necessary</li> <li>2. Check battery cable for compatibility, use higher cross-section if necessary</li> <li>3. Check conductive parts (e.g. cables, terminals, cable lugs) for damage</li> </ol>

Symptom	Possible cause	Solution
Acoustic signal sounds 4x times and red LED flashes	Input voltage too high (see table)	<ol style="list-style-type: none"> <li>1. Check voltage</li> <li>2. Check the charging voltage of the battery charger</li> <li>3. Check for unwanted voltage sources</li> </ol>
Acoustic signal sounds 5x times and red LED flashes	Inverter is overheated	<ol style="list-style-type: none"> <li>1 Check the function of the fan; if defective, call support</li> <li>2 Check the ventilation inlets and outlets for free movement</li> <li>3. Check whether there is enough cool ambient air</li> <li>4. Reduce power</li> </ol>
Acoustic signal sounds 11x times and red LED flashes	Maximum short-term power output was achieved	<ol style="list-style-type: none"> <li>1. Switch off inverter</li> <li>2. Reduce power</li> <li>3. Cool inverter</li> </ol>

### Additional possible faults for inverters with integrated charger

Symptom	Possible cause	Solution
Charger does not work	Input voltage parameters are out of tolerance	Check input source for correct voltage and frequency
Charger only supplies low currents	Low input voltage One or more batteries not connected/ defective	Use correct AC voltages Check all connections
No charging function, despite shore power connection	<ol style="list-style-type: none"> <li>1. One or more batteries defective</li> <li>2. Battery fuse defective</li> <li>3. Battery cable defective or damaged</li> <li>4. Charger defective</li> </ol>	<ol style="list-style-type: none"> <li>1. Check the batteries and replace them if necessary</li> <li>2. Check the fuse and blow it out if necessary</li> <li>3. Check the cable, if necessary, scanning out cables</li> <li>4. Contact manufacturer/ dealer</li> </ol>

## Possible configurations of batteries

When using multiple batteries, depending on the version of the inverter (12V, 24V), several configuration options of the battery banks are available.

- **Series circuits** (serial): Voltages add up, capacity remains unchanged.
- **Parallel circuits** (parallel): Capacities add up, voltage remains unchanged.
- **Series and parallel connection** (serial and parallel): Capacities and voltages add up.

### Examples:

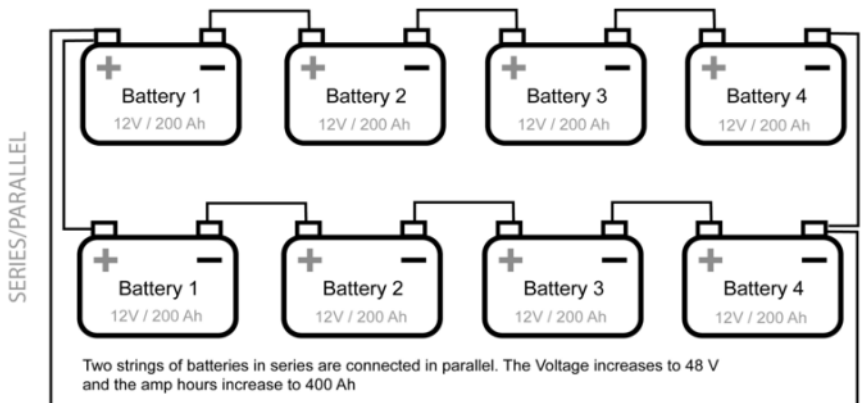
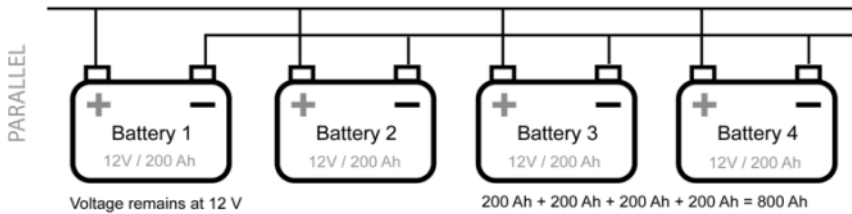
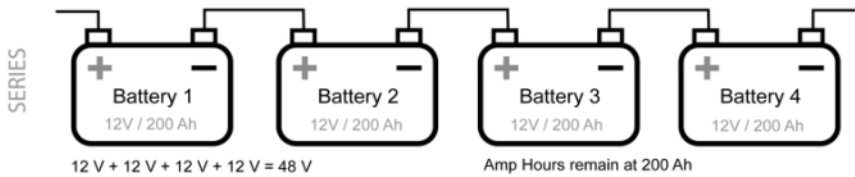

## Overwintering / Prolonged non-use

---

### **Note!**

If the inverter is not used for a longer period of time, please observe the following instructions to protect your battery from discharging:

1. Disconnect all consumers from the inverter.
2. Disconnect the battery from the inverter.

**Without complete disconnection of the battery, the inverter can continue to draw a minimum current.**

## Warranty

---

In principle, the statutory warranty period applies. If you have a complaint, please contact the manufacturer's branch in your country or the relevant point of sale.

The warranty is limited to the repair or replacement of a defective device. Removal and service costs will not be reimbursed.

In order to achieve the fastest possible warranty processing, you must send the following information.

- A copy of the invoice with a purchase date.
- A complaint or a description of the error.

### **Note!**

Liability for damages is excluded in the following cases:

- Damage to the device due to overvoltages and mechanical influences.
- Assembly errors and connection faults.
- Use of the device for purposes other than described.
- Structural modifications to the device without written permission from the manufacturer.
- Consequential damage caused by the use of **MEXXSUN** inverters.
- Any errors in this manual and consequential damages resulting therefrom.

## Disposal

---



Please dispose of all packaging material properly or recycle it.

Do not dispose of this product in your normal household waste, but in accordance with local regulations.

### **Note!**

If the device is decommissioned, please contact the nearest recycling centre or your point of sale and be informed about the latest disposal regulations.

Your municipality or local authority can provide information on disposal.

*All information is provided to the best of the author's knowledge. However, the latter cannot accept any liability for errors or incorrect operation.*

*No liability is assumed for printing errors or operating errors and their consequential damages. Technical changes are possible without prior notice.*

All rights reserved. The content of this document may not be reproduced, passed on or distributed in any form, in whole or in part, without the prior written consent of the manufacturer.



**MEXXSUN YENİLENEBİLİR ENERJİ LTD ŞTİ.**

**Fevzi Çakmak Mah. 1. Ertürk Sk. No:24 Uşak / Merkez/Türkiye**

**[www.mexxsun.com](http://www.mexxsun.com)**